

Position	Quantité	Description
	1	<p data-bbox="379 161 513 192">SBA 3-45 M</p> <div data-bbox="405 219 705 1124" style="text-align: center;">  </div> <p data-bbox="762 1169 1238 1196" style="text-align: center;">Note ! La photo produit peut différer du produit réel</p> <p data-bbox="379 1200 625 1227">Référence: 97896289</p> <p data-bbox="379 1290 1433 1415">Grundfos SBA 3-45 M is an all-in-one submersible booster designed for pumping clean water for domestic use. The SBA is built on the proven SB platform and comes with an integrated control unit. This eliminates the need for an external pump controller in the house. It is silent when submerged and therefore a noiseless alternative to surface-mounted pumps. The pump is built from high quality composite and stainless steel materials that are resistant to corrosion.</p> <p data-bbox="379 1460 1433 1514">The SBA 3-45 M is equipped with a 15 m supply cable, and the maximum installation depth is 10 m below the water level, with a liquid temperature ranging from 0 °C to 40 °C.</p> <p data-bbox="379 1550 1184 1576">The pump starts automatically when the pipe pressure falls below 2.2 bar.</p> <p data-bbox="379 1608 1455 1662">The SBA 3-45 M is ideal for operation in a well or ground tanks, as it easily prevents solid particles from entering the pump. The maximum particle size is 1 mm.</p> <p data-bbox="379 1756 1455 1809">The single-phase model is effectively protected against any accidental overload by built-in thermal protection.</p> <p data-bbox="379 1845 1455 1899">The pump has built-in thermal protection, which immediately stops the pump if it overheats. Having cooled down, the pump automatically restarts when it reaches a normal temperature.</p> <p data-bbox="379 1989 858 2110"> Liquide: Liquide pompé: Eau Plage température liquide: 0 .. 40 °C Liquid temperature during operation: 20 °C </p>

Position	Quantité	Description
		<p>Masse volumique: 998.2 kg/m³</p> <p>Technique: Débit nominal: 2.83 m³/h Hmt nom.: 30.1 m Particule maxi: 1 mm Tolérance courbe: ISO9906:2012 3B Return valve: YES Rated driver speed: 2800 mn-1</p> <p>Matériaux: Corps de pompe: Composite Roue: Composite</p> <p>Installation: Plage température ambiante: -10 .. 50 °C Type of inlet connection: STRAINER Refoulement pompe: G 1" Profondeur maximum d'installation: 10 m</p> <p>Donnée électrique: Motor protec: YES Insulation: F Power input P1: 1.05 kW Fréquence d'alimentation: 50 Hz Tension nominale: 220-240 V I start: 12 A Cos phi: 0.94 Capacité Condensateur - Fonctionnement: 13 µF/450 V Indice de protection (IEC 34-5): IP68 Length of cable: 15 m Type câble: H07RN-F 3G1 Type de fiche câble: SCHUKO P2: 0.62 kW Rated current: 4.8 A</p> <p>Autres: Poids net: 9.49 kg Poids brut: 10.2 kg Volume d'expédition: 0.022 m3 Danish VVS No.: 391366045 Swedish RSK No.: 5850420 Finnish: LVI NO 4822545 Norwegian NRF no.: 9041876 Approvals: CE,VDE,WEEE Country of origin: IT Custom tariff no.: 84137029</p>

97896289 SBA 3-45 M 50 Hz

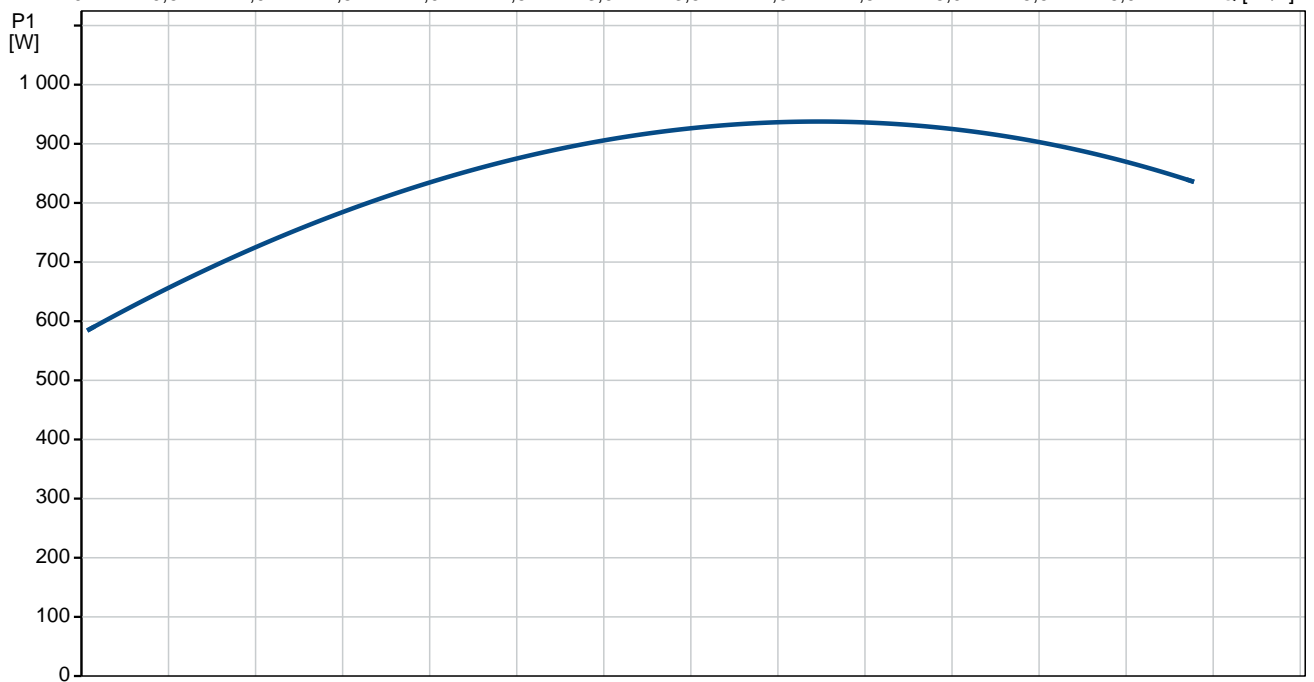
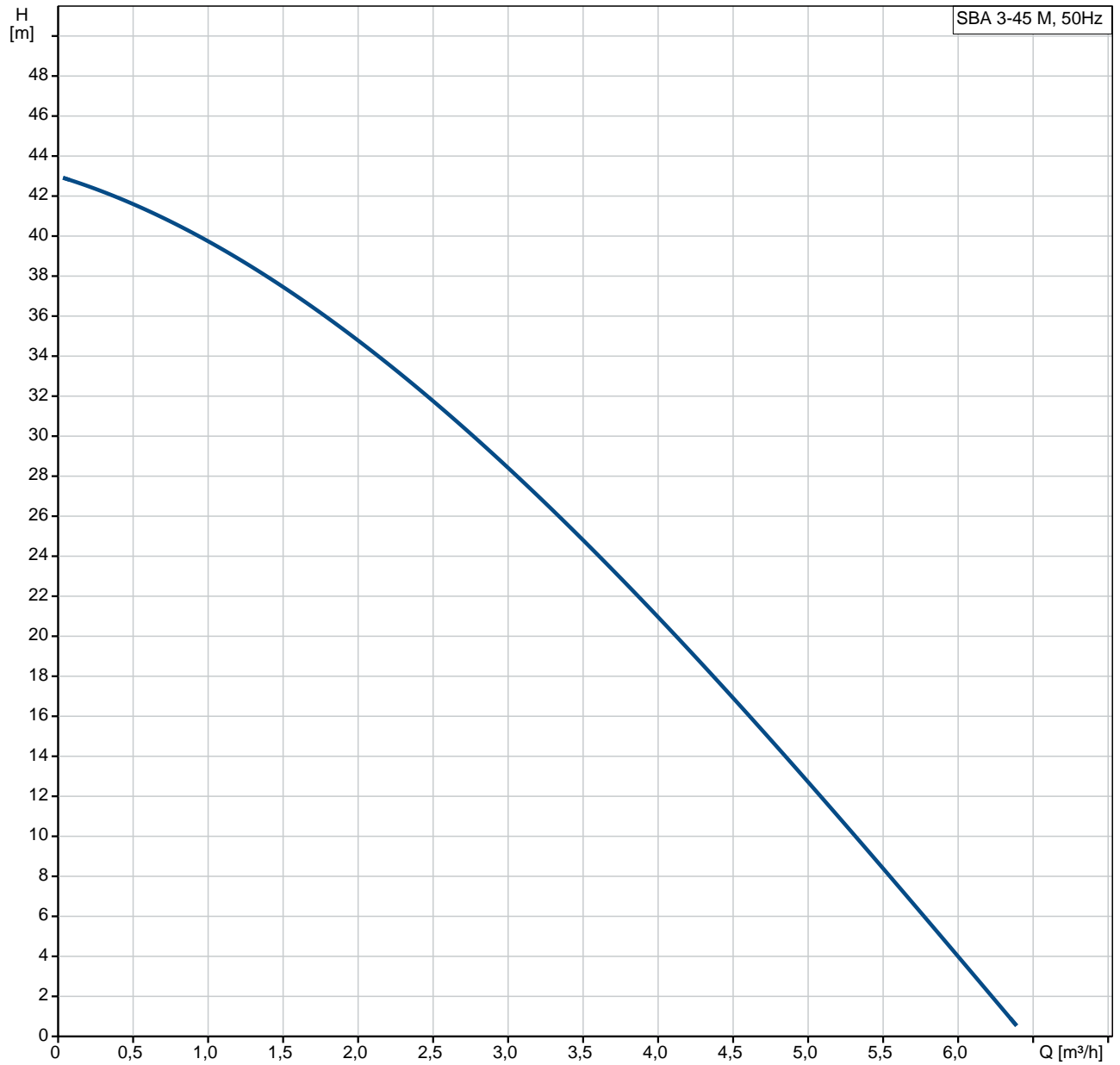

97896289 SBA 3-45 M 50 Hz

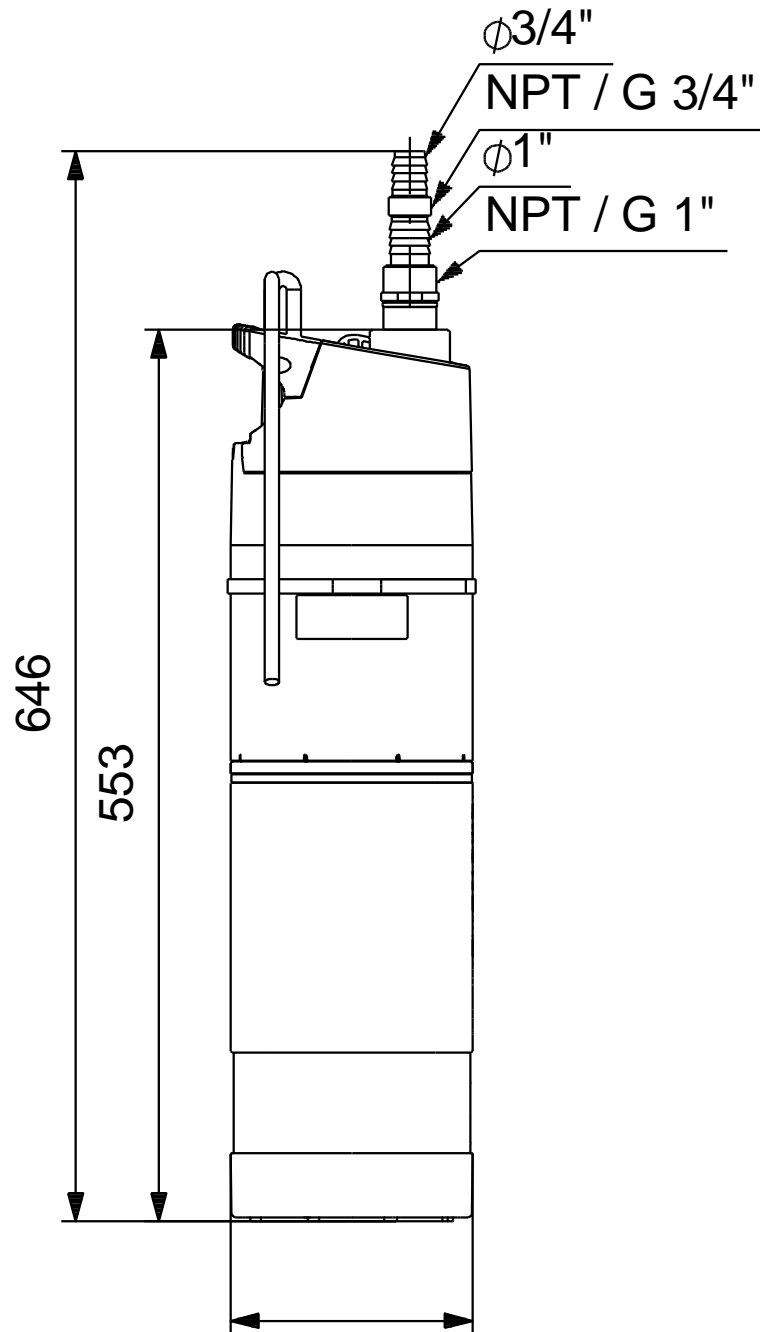

Remarque:toutes les unités sont en [mm] à moins que d'autres unités soient énoncées.
Mise en garde: ce dessin d'encombrement simplifié ne montre pas tous les détails.